



Technical comercial data

N-4.2 T.N-5.8

Serie NOVA – Versión 14-02-2024

TECHNICAL DATA:

Material:	PP copolymer of first quality, suitable for contact with food according to current regulations.
Colours:	White standard. Consult for other colours.
Useful Volume:	4.2 litres
Volume to the edge:	5.3 litres
Weight of the bucket:	174 g. approx.
Weight of the lid:	60 g. approx.
Weight of the handle (plastic):	8 g. approx.
Total Weight:	242 g. approx.
Decorative surface flat inks:	120 x 597 mm (height x perimeter)
Design surface photographic finish:	126 x 615 mm (height x perimeter)



MEASUREMENTS:

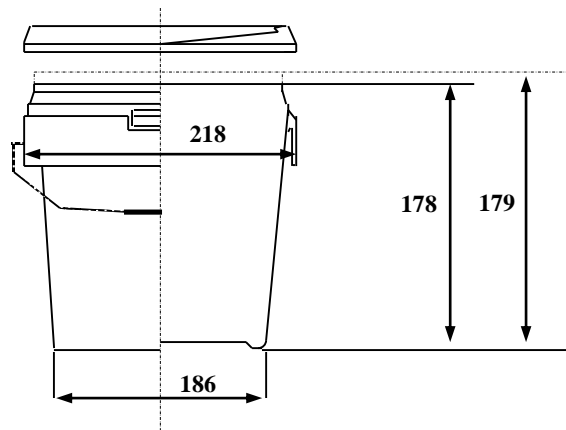

Measurements in millimetres

GROUPING OF TRANSPORT:

Buckets:	600 buckets per pallet
Pallet dimensions:	1150 x 872 x 1100 (see drawing)
Lids:	200 lids per box, this serves as a packaging of transportation
Box dimension:	483 x 244 x 815

